

# TC7WH32FU, TC7WH32FK

## Dual 2-Input OR Gate

The TC7WH32 is an advanced high speed CMOS 2-Input OR Gate fabricated with silicon gate CMOS technology. It achieves the high speed operation similar to equivalent Bipolar Schottky TTL while maintaining the CMOS low power dissipation. The internal circuit is composed of 4 stages including buffer output, which provide high noise immunity and stable output. An input protection circuit ensures that 0 to 7 V can be applied to the input pins without regard to the supply voltage. This device can be used to interface 5 V to 3 V systems and two supply systems such as battery back up. This circuit prevents device destruction due to mismatched supply and input voltages.

### Features

- High speed:  $t_{pd} = 3.8 \text{ ns (typ.)}$  at  $V_{CC} = 5 \text{ V}$
- Low power dissipation:  $I_{CC} = 2 \mu\text{A (max)}$  at  $T_a = 25^\circ\text{C}$
- High noise immunity:  $V_{NIH} = V_{NIL} = 28\% V_{CC} \text{ (min)}$
- Power down protection is provided on all inputs.
- Balanced propagation delays:  $t_{pLH} \approx t_{pHL}$
- Wide operating voltage range:  $V_{CC} \text{ (opr)} = 2\sim 5.5 \text{ V}$

### Marking

SM8

US8

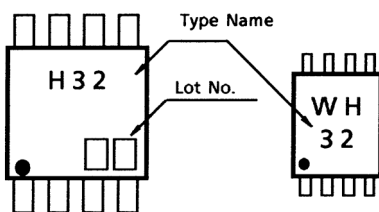

### Pin Assignment (top view)

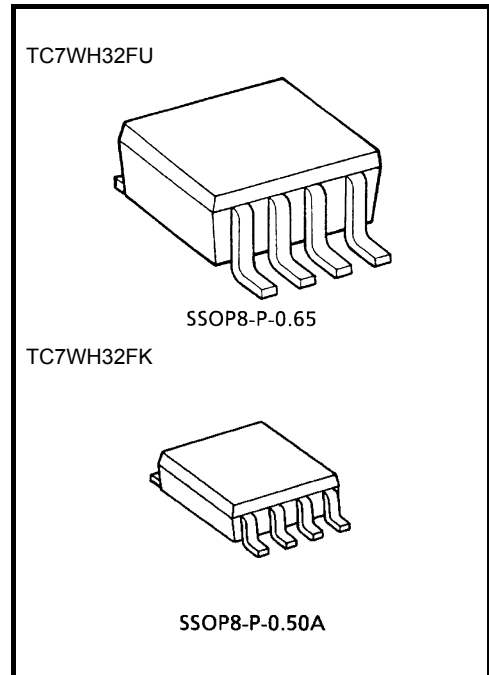
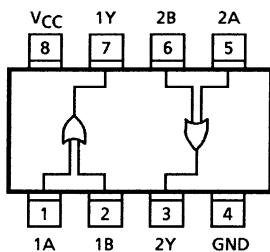

Weight

SSOP8-P-0.65: 0.02 g (typ.)

SSOP8-P-0.50A: 0.01 g (typ.)

## Logic Diagram

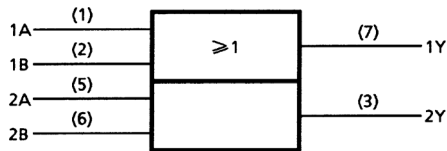

## Truth Table

A	B	Y
H	H	H
L	H	H
H	L	H
L	L	L

## Absolute Maximum Ratings (Ta = 25°C)

Characteristics	Symbol	Rating	Unit
Supply voltage range	V <sub>CC</sub>	-0.5~7.0	V
DC input voltage	V <sub>IN</sub>	-0.5~7.0	V
DC output voltage	V <sub>OUT</sub>	-0.5~V <sub>CC</sub> + 0.5	V
Input diode current	I <sub>IK</sub>	-20	mA
Output diode current	I <sub>OK</sub>	±20	mA
DC output current	I <sub>OUT</sub>	±25	mA
DC V <sub>CC</sub> /ground current	I <sub>CC</sub>	±50	mA
Power dissipation	P <sub>D</sub>	300 (SM8)	mW
		200 (US8)	
Storage temperature	T <sub>stg</sub>	-65~150	°C
Lead temperature (10 s)	T <sub>L</sub>	260	°C

Note: Using continuously under heavy loads (e.g. the application of high temperature/current/voltage and the significant change in temperature, etc.) may cause this product to decrease in the reliability significantly even if the operating conditions (i.e. operating temperature/current/voltage, etc.) are within the absolute maximum ratings and the operating ranges.

Please design the appropriate reliability upon reviewing the Toshiba Semiconductor Reliability Handbook ("Handling Precautions"/"Derating Concept and Methods") and individual reliability data (i.e. reliability test report and estimated failure rate, etc).

## Operating Ranges

Characteristics	Symbol	Rating	Unit
Supply voltage	V <sub>CC</sub>	2.0~5.5	V
Input voltage	V <sub>IN</sub>	0~5.5	V
Output voltage	V <sub>OUT</sub>	0~V <sub>CC</sub>	V
Operating temperature	T <sub>opr</sub>	-40~85	°C
Input rise and fall time	dt/dv	0~100 (V <sub>CC</sub> = 3.3 ± 0.3 V)	ns/V
		0~20 (V <sub>CC</sub> = 5 ± 0.5 V)	

## Electrical Characteristics

### DC Characteristics

Characteristics	Symbol	Test Condition	V <sub>CC</sub> (V)	Ta = 25°C			Ta = -40~85°C		Unit	
				Min	Typ.	Max	Min	Max		
High-level input voltage	V <sub>IH</sub>	—	2.0	1.50	—	—	1.50	—	V	
			3.0~5.5	V <sub>CC</sub> × 0.7	—	—	V <sub>CC</sub> × 0.7	—		
Low-level input voltage	V <sub>IL</sub>	—	2.0	—	—	0.50	—	0.50	V	
			3.0~5.5	—	—	V <sub>CC</sub> × 0.3	—	V <sub>CC</sub> × 0.3		
High-level output voltage	V <sub>OH</sub>	V <sub>IN</sub> = V <sub>IH</sub> or V <sub>IL</sub>	I <sub>OH</sub> = -50 μA	2.0	1.9	2.0	—	1.9	—	V
				3.0	2.9	3.0	—	2.9	—	
			I <sub>OH</sub> = -4 mA	4.5	4.4	4.5	—	4.4	—	
				4.5	3.94	—	—	3.80	—	
Low-level output voltage	V <sub>OL</sub>	V <sub>IN</sub> = V <sub>IL</sub>	I <sub>OL</sub> = 50 μA	2.0	—	0.0	0.1	—	0.1	V
				3.0	—	0.0	0.1	—	0.1	
				4.5	—	0.0	0.1	—	0.1	
			I <sub>OL</sub> = 4 mA	3.0	—	—	0.36	—	0.44	
				4.5	—	—	0.36	—	0.44	
Input leakage current	I <sub>IN</sub>	V <sub>IN</sub> = 5.5 V or GND	0~5.5	—	—	±0.1	—	±1.0	μA	
Quiescent supply current	I <sub>CC</sub>	V <sub>IN</sub> = V <sub>CC</sub> or GND	5.5	—	—	2.0	—	20.0	μA	

### AC Characteristics (input: t<sub>r</sub> = t<sub>f</sub> = 3 ns)

Characteristics	Symbol	Test Condition		Ta = 25°C			Ta = -40~85°C		Unit	
		V <sub>CC</sub> (V)	C <sub>L</sub> (pF)	Min	Typ.	Max	Min	Max		
Propagation delay time	t <sub>pLH</sub> t <sub>pHL</sub>	—	3.3 ± 0.3	15	—	5.5	7.9	1.0	9.5	ns
				50	—	8.0	11.4	1.0	13.0	
			5.0 ± 0.5	15	—	3.8	5.5	1.0	6.5	
				50	—	5.3	7.5	1.0	8.5	
Input capacitance	C <sub>IN</sub>	—		—	4	10	—	10	pF	
Power dissipation capacitance	C <sub>PD</sub>	(Note)		—	14	—	—	—	pF	

Note: C<sub>PD</sub> is defined as the value of the internal equivalent capacitance which is calculated from the operating current consumption without load.

Average operating current can be obtained by the equation:

$$I_{CC (opr)} = C_{PD} \cdot V_{CC} \cdot f_{IN} + I_{CC}/2$$

## Noise Characteristics (Ta = 25°C, input: tr = tf = 3 ns)

Characteristics	Symbol	Test Condition	V <sub>CC</sub> (V)	Typ.	Limit	Unit
Quiet output maximum dynamic V <sub>OL</sub>	V <sub>OLP</sub>	C <sub>L</sub> = 50 pF	5.0	0.3	0.8	V
Quiet output minimum dynamic V <sub>OL</sub>	V <sub>OLV</sub>	C <sub>L</sub> = 50 pF	5.0	-0.3	-0.8	V
Minimum high level dynamic input voltage	V <sub>IHD</sub>	C <sub>L</sub> = 50 pF	5.0	—	3.5	V
Maximum low level dynamic input voltage	V <sub>ILD</sub>	C <sub>L</sub> = 50 pF	5.0	—	1.5	V

## Input Equivalent Circuit

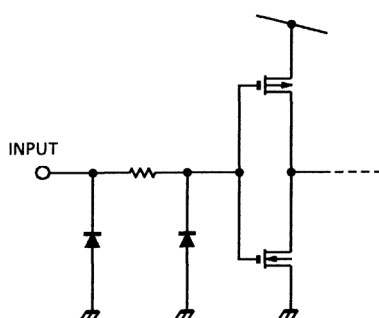

**Package Dimensions**

SSOP8-P-0.65

Unit : mm

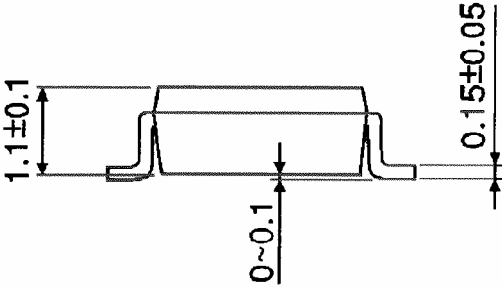
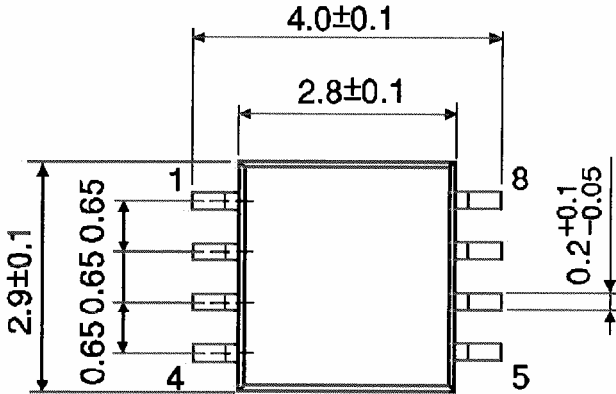

Weight: 0.02 g (typ.)

Package Dimensions

SSOP8-P-0.50A

Unit : mm

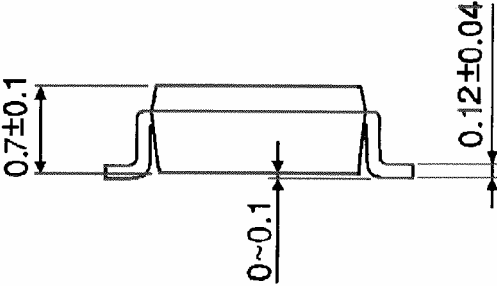
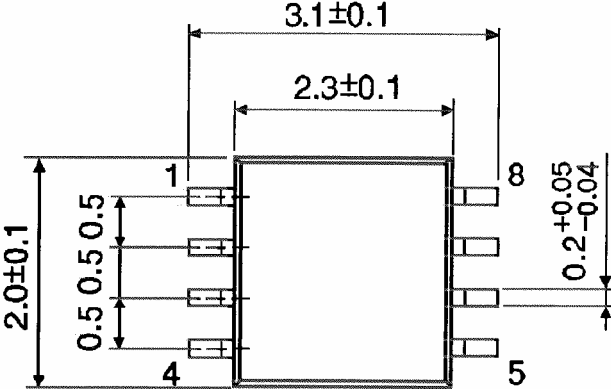

Weight: 0.01 g (typ.)

**RESTRICTIONS ON PRODUCT USE**

20070701-EN GENERAL

- The information contained herein is subject to change without notice.
- TOSHIBA is continually working to improve the quality and reliability of its products. Nevertheless, semiconductor devices in general can malfunction or fail due to their inherent electrical sensitivity and vulnerability to physical stress. It is the responsibility of the buyer, when utilizing TOSHIBA products, to comply with the standards of safety in making a safe design for the entire system, and to avoid situations in which a malfunction or failure of such TOSHIBA products could cause loss of human life, bodily injury or damage to property.  
In developing your designs, please ensure that TOSHIBA products are used within specified operating ranges as set forth in the most recent TOSHIBA products specifications. Also, please keep in mind the precautions and conditions set forth in the "Handling Guide for Semiconductor Devices," or "TOSHIBA Semiconductor Reliability Handbook" etc.
- The TOSHIBA products listed in this document are intended for usage in general electronics applications (computer, personal equipment, office equipment, measuring equipment, industrial robotics, domestic appliances, etc.). These TOSHIBA products are neither intended nor warranted for usage in equipment that requires extraordinarily high quality and/or reliability or a malfunction or failure of which may cause loss of human life or bodily injury ("Unintended Usage"). Unintended Usage include atomic energy control instruments, airplane or spaceship instruments, transportation instruments, traffic signal instruments, combustion control instruments, medical instruments, all types of safety devices, etc.. Unintended Usage of TOSHIBA products listed in this document shall be made at the customer's own risk.
- The products described in this document shall not be used or embedded to any downstream products of which manufacture, use and/or sale are prohibited under any applicable laws and regulations.
- The information contained herein is presented only as a guide for the applications of our products. No responsibility is assumed by TOSHIBA for any infringements of patents or other rights of the third parties which may result from its use. No license is granted by implication or otherwise under any patents or other rights of TOSHIBA or the third parties.
- Please contact your sales representative for product-by-product details in this document regarding RoHS compatibility. Please use these products in this document in compliance with all applicable laws and regulations that regulate the inclusion or use of controlled substances. Toshiba assumes no liability for damage or losses occurring as a result of noncompliance with applicable laws and regulations.